

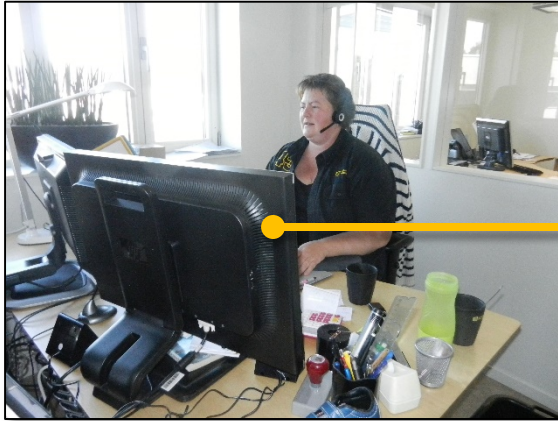

# **Radio over IP Examples**

# Small system



PC Dispatcher



Ip controlled radio



Radio in lorry



# Remote system

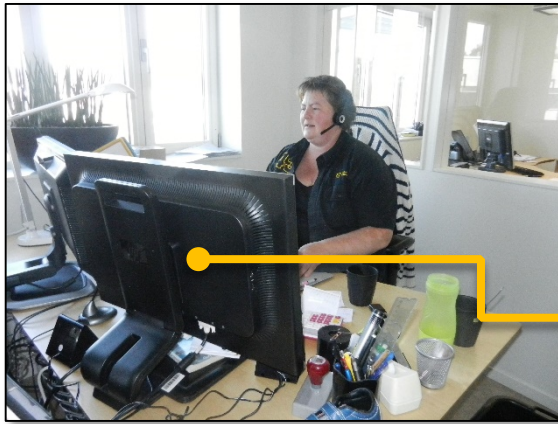

PC Dispatcher

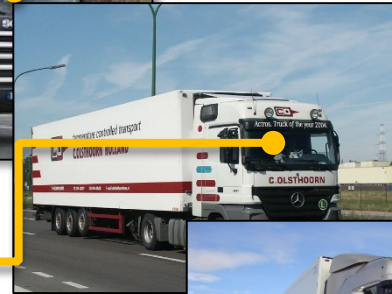
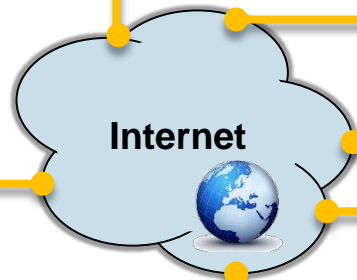

# Remote system

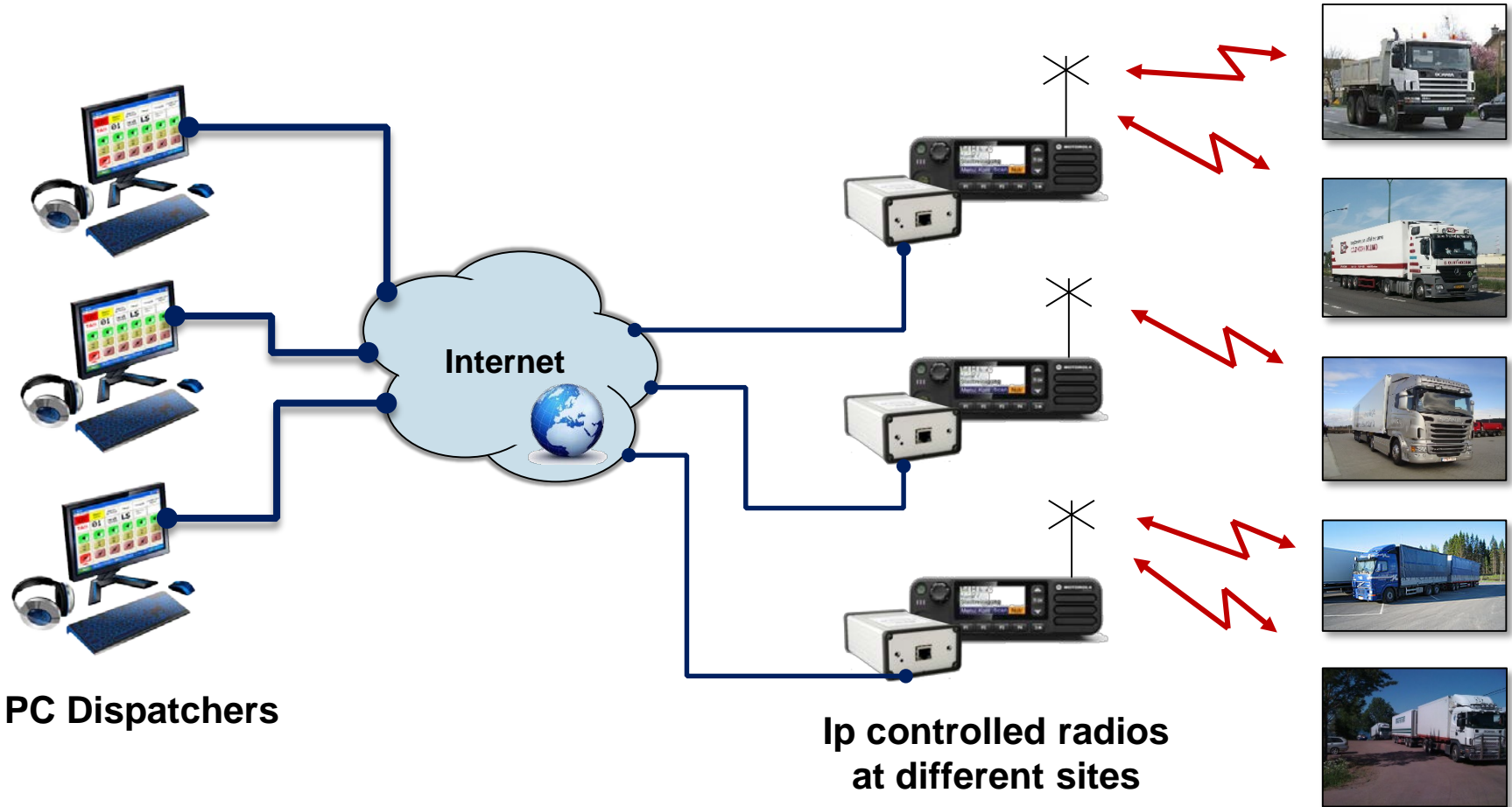

PC Dispatchers

Ip controlled radios  
at different sites

# Airports

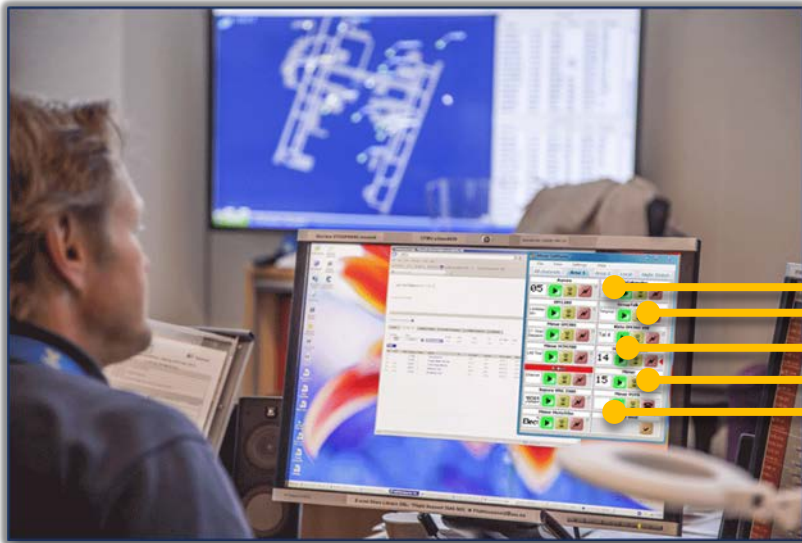
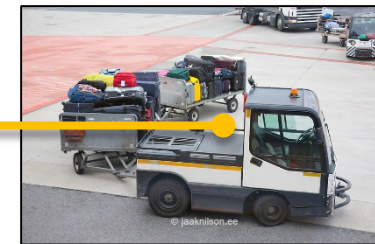
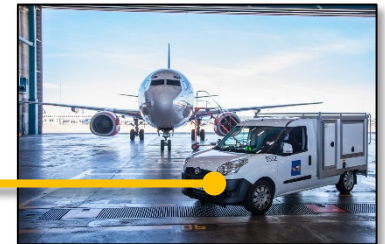
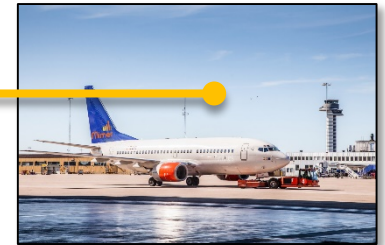





Tetra radio in service vehicle



SmartPhone on Pilot



Airband radio in plane



Other radio types at other airports



Operator Center

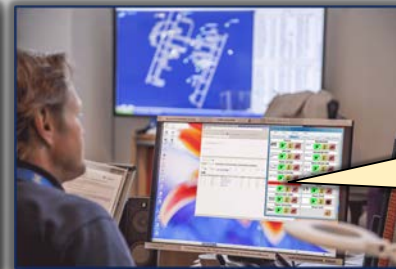

Virtual Control Head

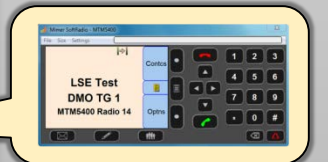



Six Tetra Radios  
For ground communication



Six Airband Radios  
For ground to air communication

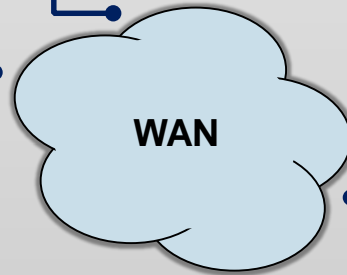

The new terminal at **Bangalore Airport**

11 Operators

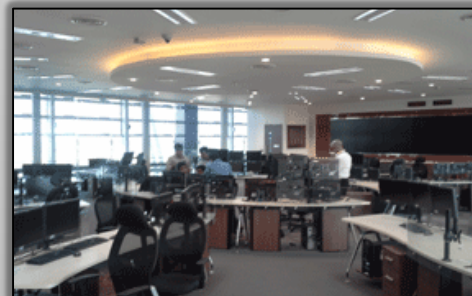



# Coast Guard





### Radios in mast

Tetra Radios

Marine VHF Radios

UHF Radio



### All equipment onboard the ship

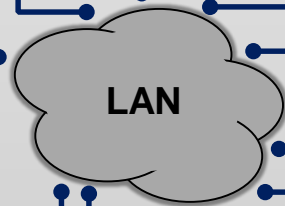

LAN

Air-VHF

Marine-VHF



### Dispatch Room



Operator PC's

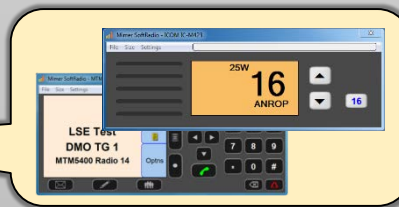

Virtual Control Heads

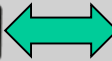

POTS

# Casinos



**Common centre for all casinos  
With radio and video control**

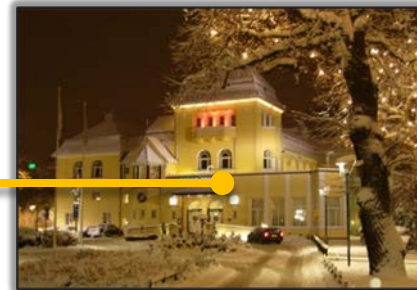
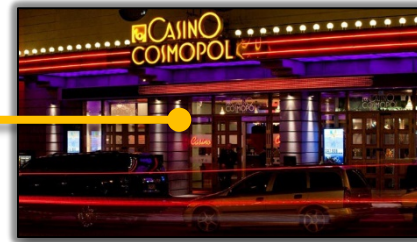

**Casinos in different towns**

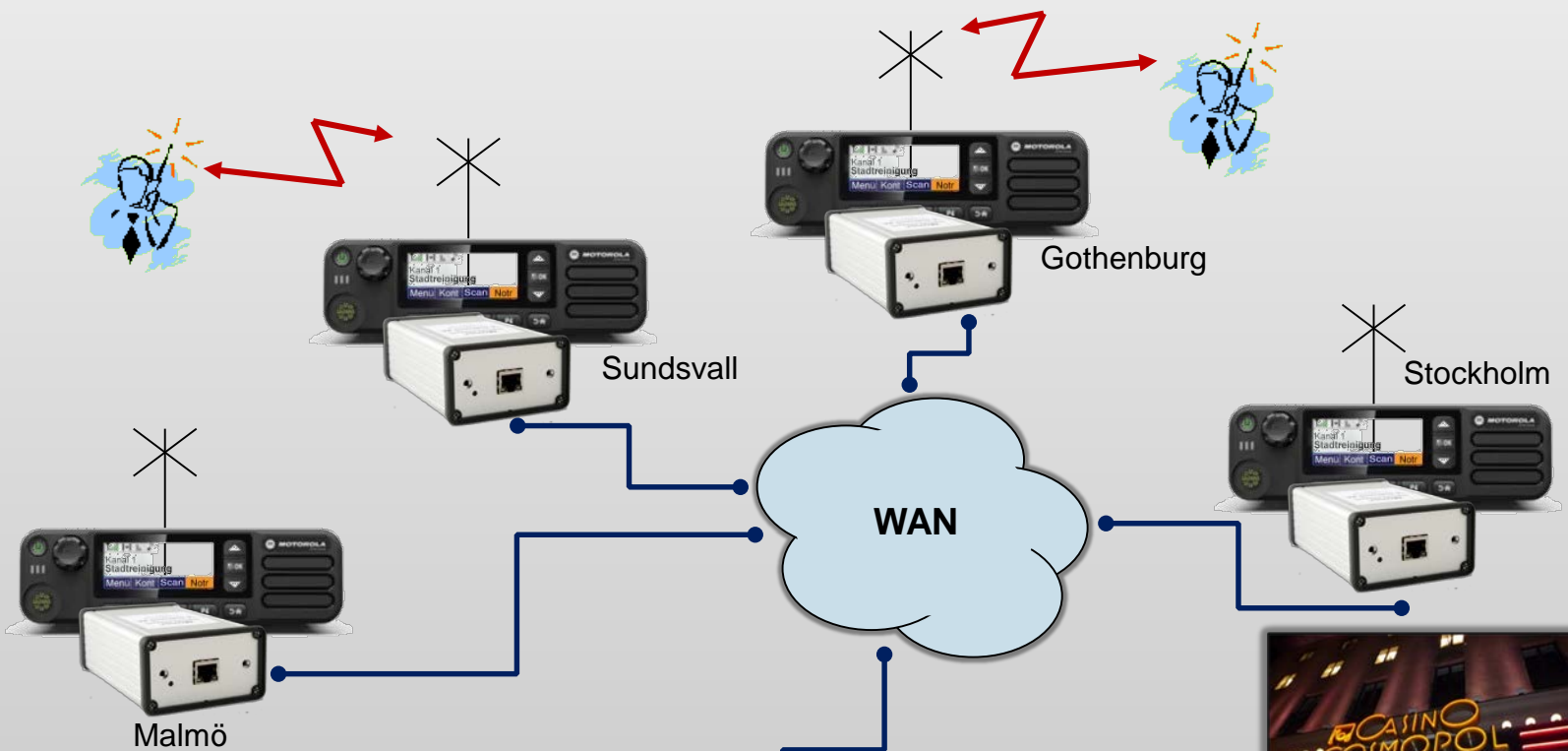

Malmö

Sundsvall

Gothenburg

Stockholm

WAN

Operator Center

Virtual Control Head



# Offshore industry



**Wind power farms**  
**Oil rigs**

**Radios offshore**  
**Operators onshore**

**Both used at building**  
**and at operation**



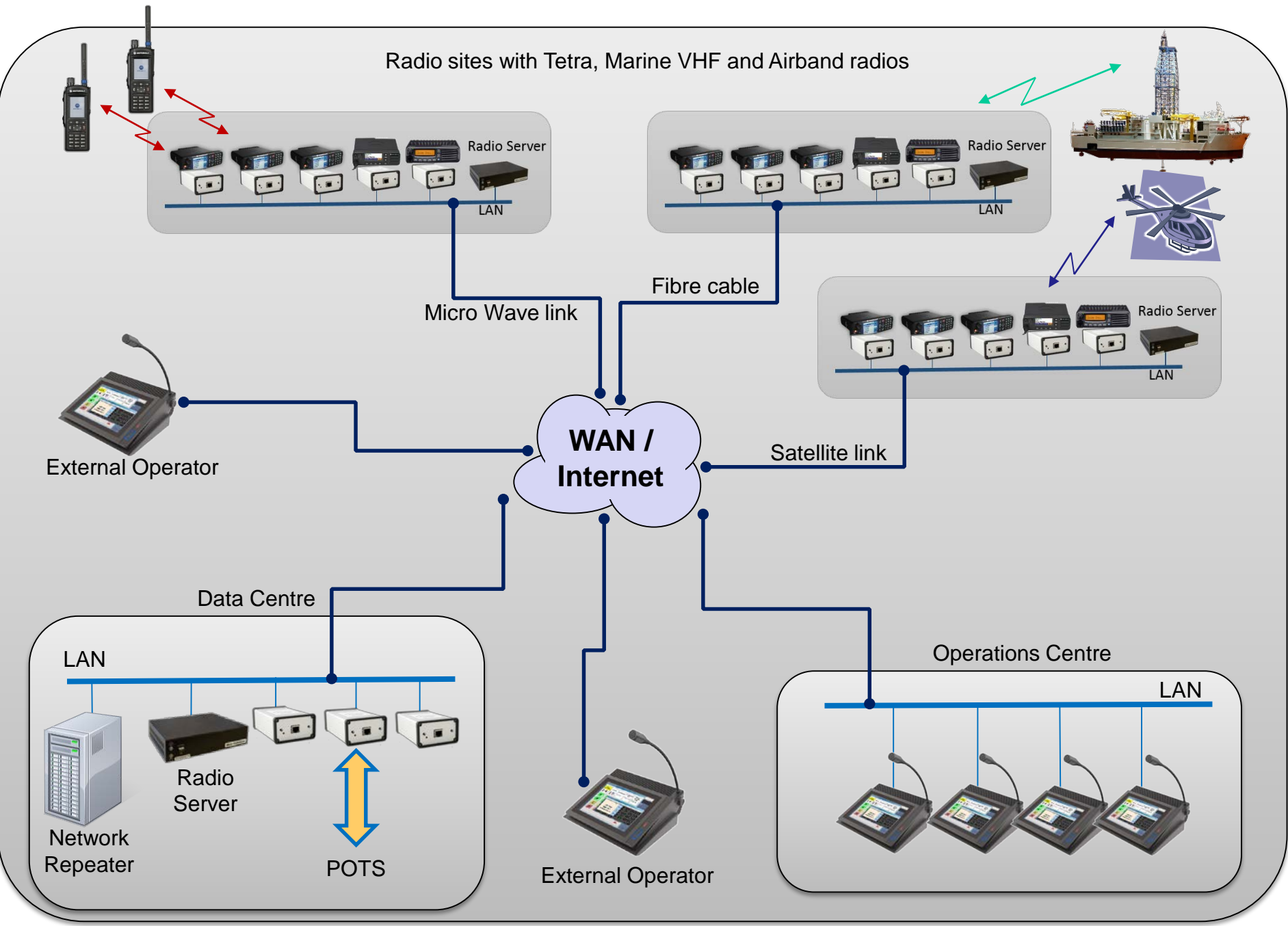

Radio sites with Tetra, Marine VHF and Airband radios

Radio Server  
LAN

Radio Server  
LAN

Radio Server  
LAN

WAN / Internet

External Operator

Data Centre

LAN

Network Repeater

Radio Server

POTS

External Operator

Operations Centre

LAN

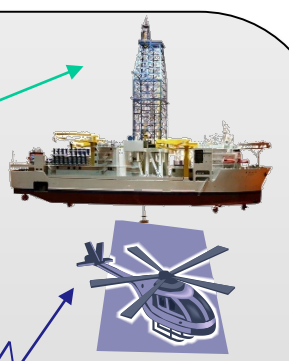



**Example of SoftRadio GUI**  
**Tetra+Marine+Airband+Phone**



# Command Control Vehicles



**Command centre on wheels  
with built in radios and phones**

Analogue and Tetra radios

POTS and GSM phones

POTS

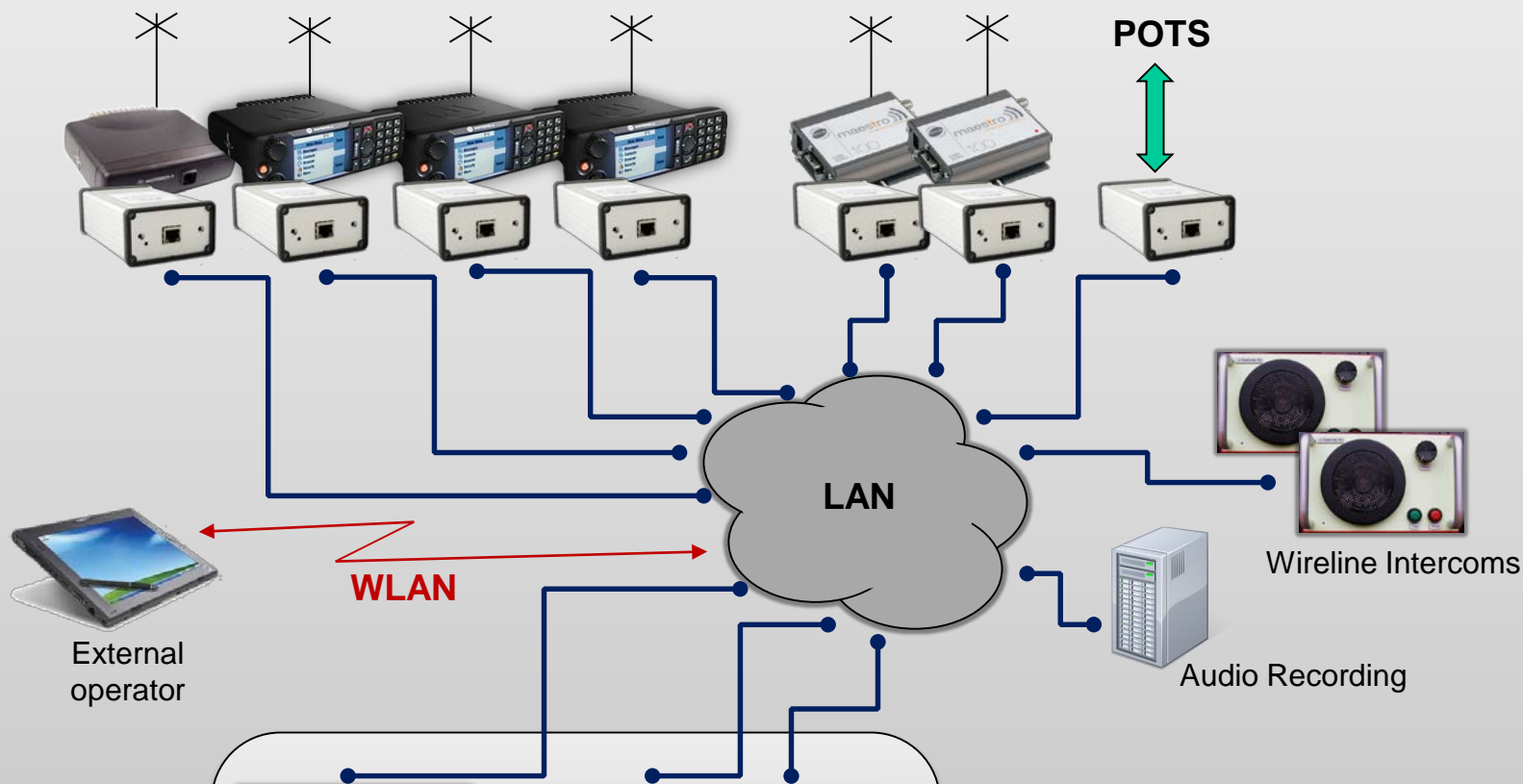

External operator

WLAN

LAN

Wireline Intercoms

Audio Recording



One operator in the front



Two operators in the back





# River Traffic Control



**River Sava**



3 x VHF Marine

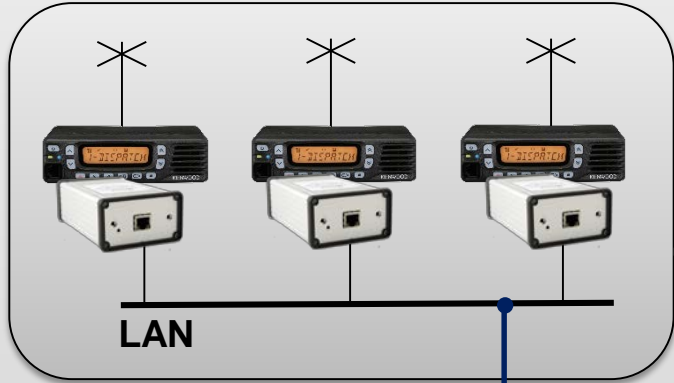

7 Radio Sites

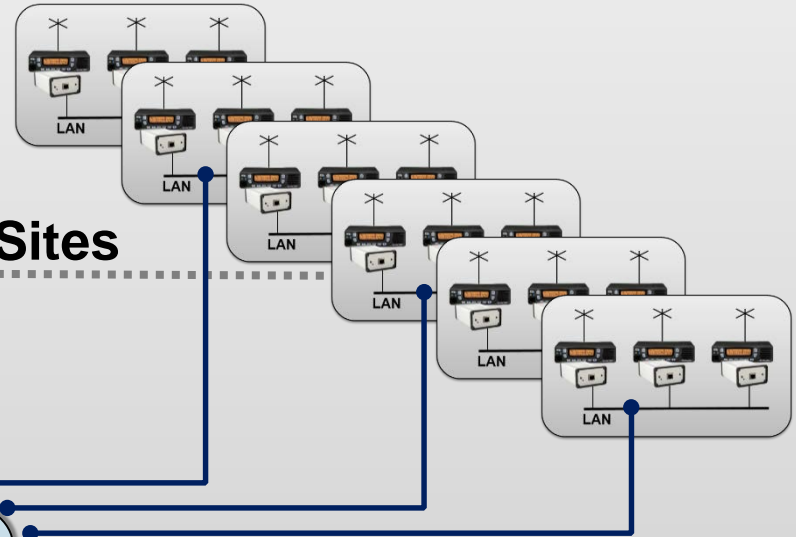

The Internet

RadioServer

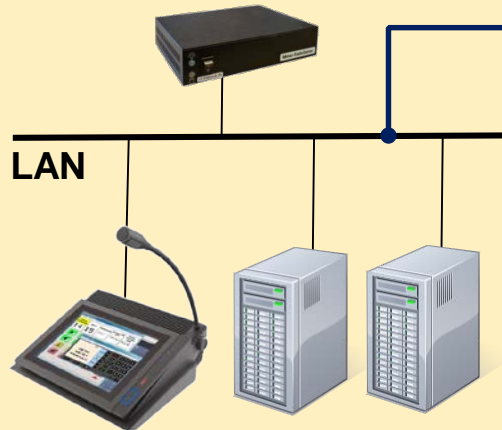

Operator 1

NetworkRepeater  
VoiceLog



Operator 2



SoftRadio with  
Virtual control heads

Operators with DSC signalling and diversity voting

# Carriers





VHF Repeater

VHF



MB



MB Base station



Local Radio VHF

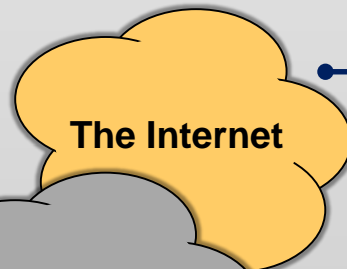

The Internet

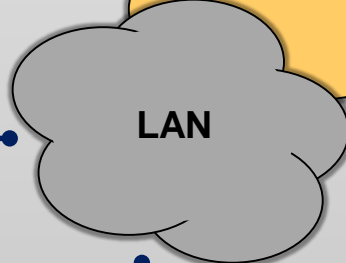

LAN

Six operators



Virtual Control Heads



# Buss Traffic Control



Så  
snackar  
**Nobina**  
ihop sig

Talad kommunikation är och förblir livlinan mellan bussförare och trafikledning. För Nobina som bedriver kollektivtrafik på entreprenad i hela Norden krävs det avancerade lösningar för att koppla samman tusentals busschaufförer med de tre centrala trafikledningscentralerna.



Örebro  
Analygue 5-tone

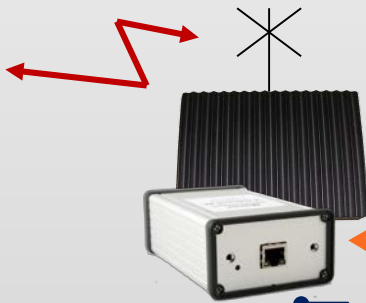

Sundsvall  
Tetra

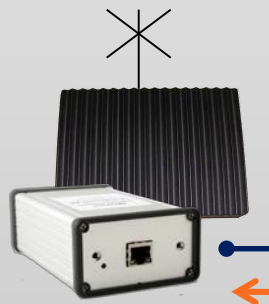

Nyköping  
Analygue 5-tone

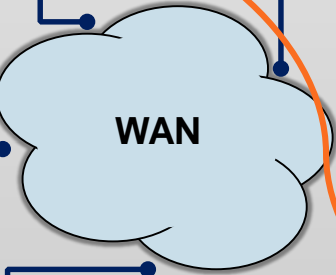

Stockholm  
Operator Center

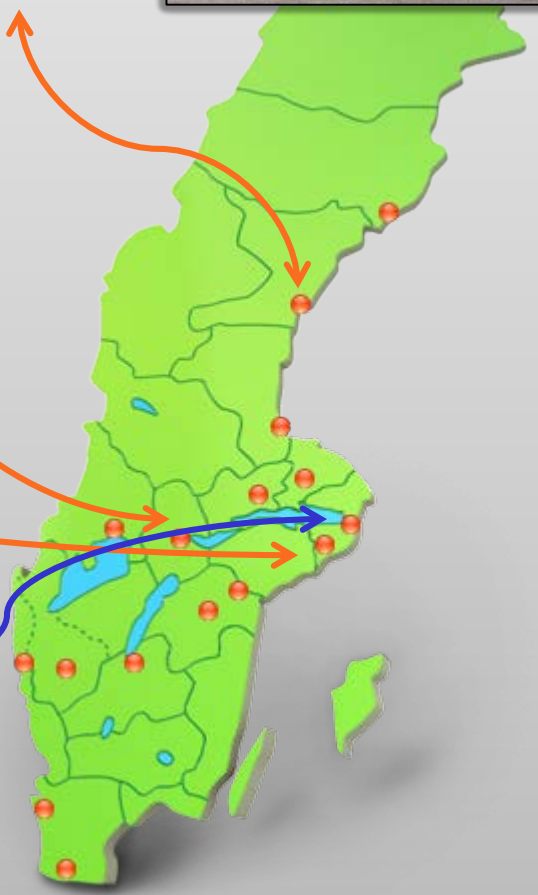

# Taxi



**A taxi central in one town  
handles cars in several towns**

